











# HOME CINEMA SPEAKER CEILING MOUNT

## ASSEMBLY AND MOUNTING INSTRUCTIONS

THIS PACK CONTAINS 1 MOUNT DESIGNED FOR SPEAKERS WITH A WEIGHT UP TO 5KG.

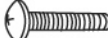
PLEASE KEEP THESE INSTRUCTIONS FOR FUTURE REFERENCE.

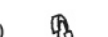
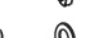
PARTS LIST / LIST DES PIÈCES / MITGELIEFERTES MONTAGEMATERIAL					
1)		x2	4)		x1
2)		x2	5)		x2
3)		x1	6)		x2
			7)		x2
			8)		x1
			9)		x1
			10)		x1
			11)		x2
			12)		x1
			13)		x1

The bracket should be mounted to a ceiling joist (a "stud locator" will help) or to a concrete ceiling. If the only location available doesn't have a joist or is not concrete, then it will be necessary to use the butterfly anchors (Wall Plugs) supplied.

**WARNING :**  
ENSURE THERE ARE NO HAZARDS BEHIND THE DRYWALL SUCH AS ELECTRICAL WIRING OR PLUMBING.

B-TECH INTERNATIONAL LTD., ITS DISTRIBUTORS AND DEALERS ARE NOT RESPONSIBLE FOR DAMAGE OR INJURY CAUSED BY IMPROPER INSTALLATION. IF YOU ARE UNCERTAIN ABOUT INSTALLING THIS BRACKET CONTACT A PROFESSIONAL INSTALLER.

BITTE BEWAHREN SIE DIESE ANLEITUNG ZUM SPAETEREN NACHSCHLAGEN

Der BT34 Wand-/Deckenhalter sollte nur auf festem Untergrund montiert werden. (Wand-/Deckenbalken oder Stahlbeton sind unbedingt vorzuziehen!) Sollte der Untergrund keinem der oben genannten Materialien entsprechen, nutzen Sie bitte Schrauben und Spezialdubel aus dem Fachhandel! Vergewissern Sie Sich, dass sich an der Montagestelle (in der Wand) keine elektrischen Leitungen oder Rohrleitungen befinden.

SVP, VEUILLEZ GARDER DES INSTRUCTIONS COMME RÉFÉRENCE.

Décidez de l'endroit où vous allez installer le support, soit sur une solive (en vous servant au besoin d'un dispositif de repérage), soit sur un plafond en béton. Faute de solives ou d'un plafond en béton à l'endroit choisi, il faudra utiliser les ancrs "Papillon" ci-incluses.

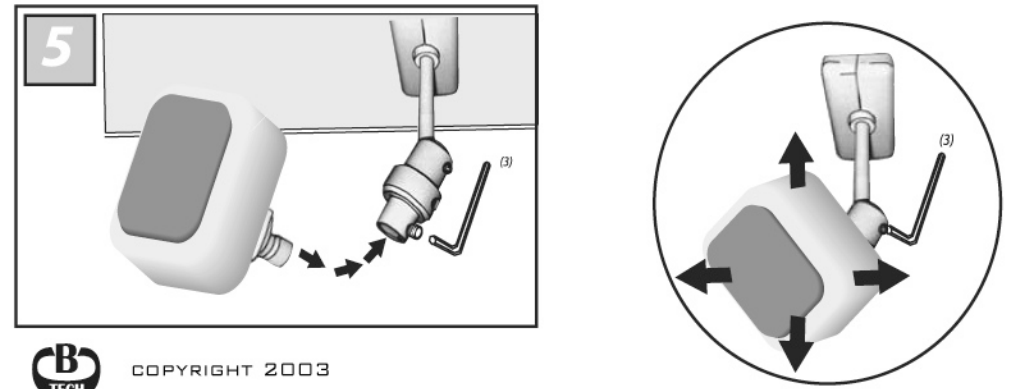
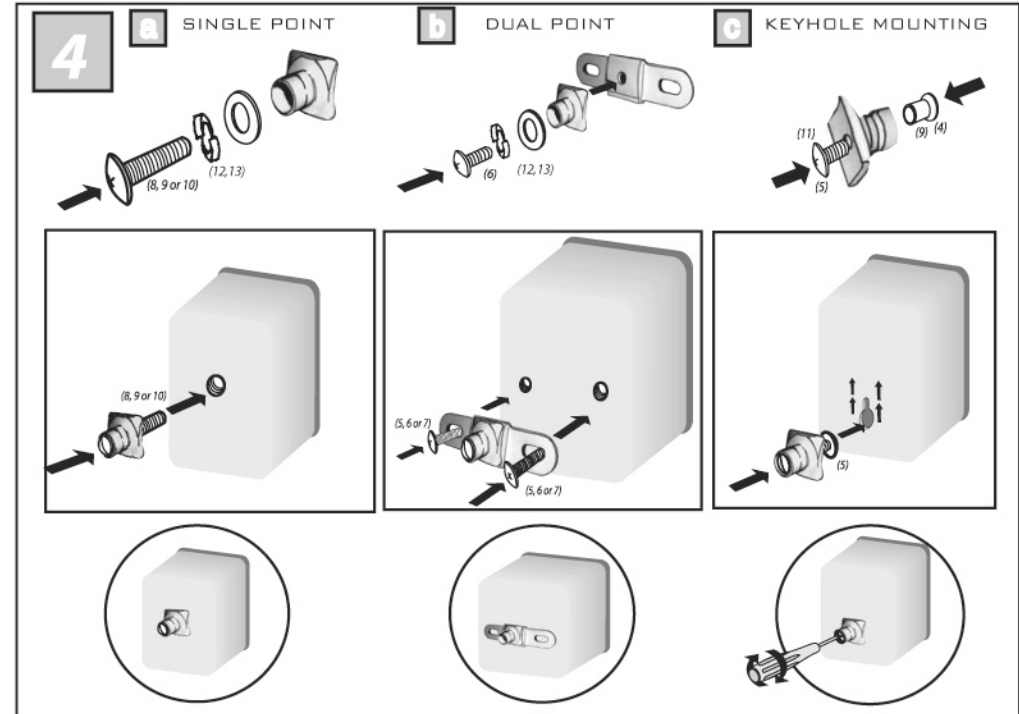
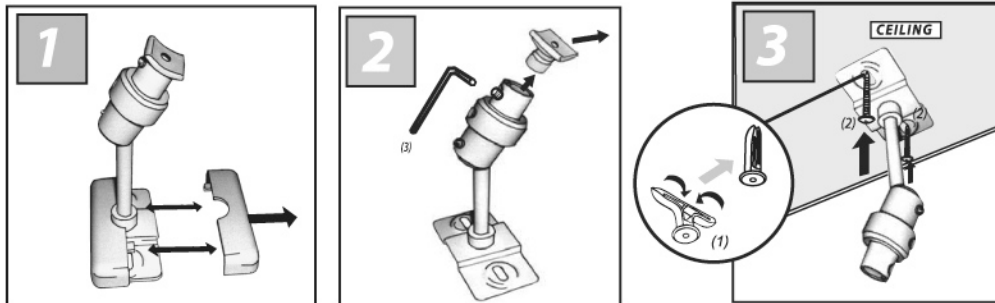

COPYRIGHT 2003

B-TECH INTERNATIONAL LIMITED, CROYDON, CR0 9UG, UK  
WWW.B-TECH-INT.COM

v0305